



XU1-DC – DC voltage relay

(June 1998)

Manual XU1-DC (Revision New)

Woodward Governor Company reserves the right to update any portion of this publication at any time. Information provided by Woodward Governor Company is believed to be correct and reliable. However, no responsibility is assumed by Woodward Governor Company unless otherwise expressly undertaken.

© Woodward 1994-2008

Contents

1. Applications and features	4
2. Design	5
3. Function	8
4. Operation and settings	9
4.1 Setting of DIP-switches	11
4.2 Setting of tripping values	13
4.3 Communication via serial interface adapter XRS1	14
5. Relay case and technical data	15
5.1 Relay case	15
5.2 Technical Data	16
6. Order form.....	18

1. Applications and features

Relay XU1-DC of the PROFESSIONAL LINE is a digital re-lay for voltage supervision of DC systems. This relay type is available in three versions. Version 1, type XU1-DC-1, with a nominal voltage range of 100 to 500 V, is mainly used for supervision of DC intermediate circuits, UPS batteries and station batteries.

Version 2 and 3, type XU1-DC-2 and XU1-DC-3, with a setting range of 24 - 60 V, are used for instance for supervision of starter batteries.

When compared to conventional protection equipment all relays of the PROFESSIONAL LINE reflect the superiority of digital protection technique with the following features:

- High measuring accuracy by digital data processing
- Fault indication via LEDs
- Extremely wide operating ranges of the supply voltage by universal wide-range power supply unit
- Very fine graded wide setting ranges
- Data exchange with process management system by serial interface adapter XRS1 which can be retrofitted
- extremely short response time
- Compact design due to SMD-technology
- In addition to this the DC voltage relays XU1-DC have the following special features:
- Rated voltage ranges selectable
- Separate adjustment of tripping delays for both tripping elements possible
- Different switching hysteresis adjustable

The relay types XU1-DC-1 and XU1-DC-2 are provided with two separate tripping elements for under- and overvoltage ($U<$, $U>$).

The XU1-DC-3 is equipped with two separate tripping elements for undervoltage ($U1<$, $U2<$).

2. Design

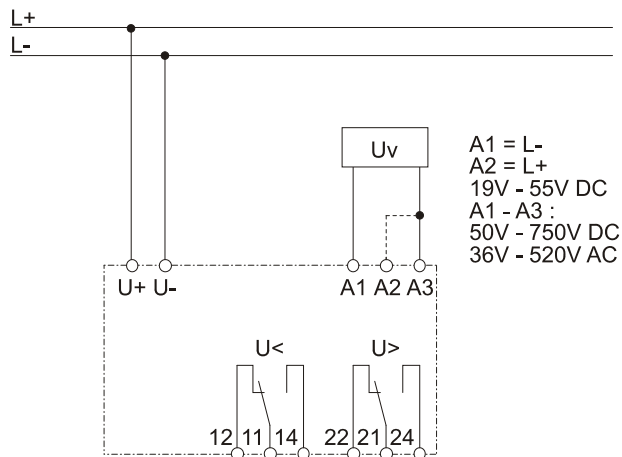

Figure 2.1: Connection XU1-DC-1

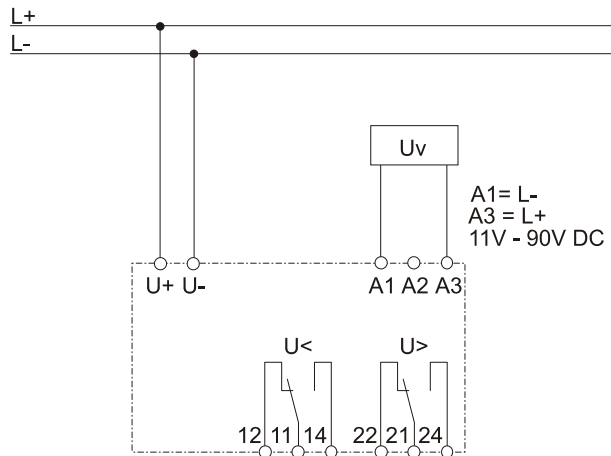

Figure 2.2: Connection XU1-DC-2

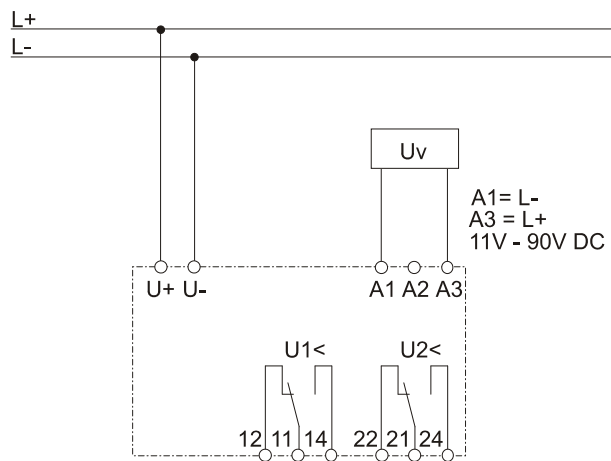

Figure 2.3: Connection XU1-DC-3

Analog inputs

DC voltage is connected to the protection relay via terminals U+ and U-.

Auxiliary voltage supply

Unit XU1-DC can be supplied from the measuring quantity itself or by secured auxiliary supply. Therefore a DC or AC voltage must be used for unit XU1-DC-1. DC-voltage supply must be used for units XU1-DC-2 and XU1-DC-3.

Unit XU1-DC has an integrated wide range power supply. The auxiliary voltage ranges are shown in the margin.

Contact positions XU1-DC-1 and XU1-DC-2

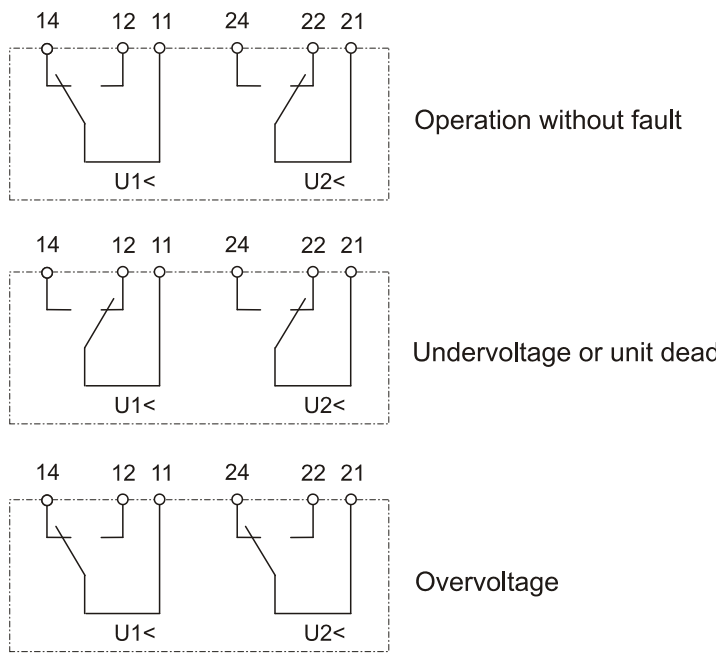

Figure 2.4: Contact positions of the output relays

Contact positions XU1-DC-3

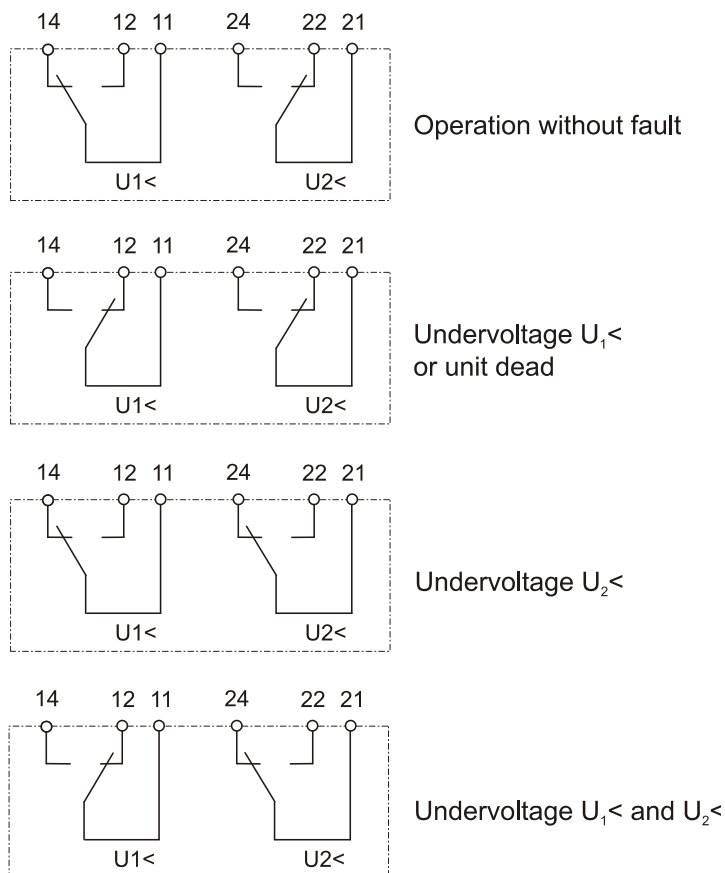

Figure 2.5: Contact positions of the output relays

3. Function

The XU1-DC is provided with one supervision each for overvoltage ($U>$) and undervoltage ($U<$); pickup value and time delays of which can be adjusted separately. The DC voltage measured is constantly compared with the set reference values. If these values are not met the respective device (either for over- or undervoltage) trips after elapse of the time delay.

Pickup of the supervision circuit, either $U>$ or $U<$, is indicated by the corresponding flashing LED. Upon trip-ping the flashing light changes to steady light.

The XU1-DC-3 is provided with two separately operating undervoltage elements ($U1<$ and $U2<$) with separately adjustable pickup values and tripping delays.

Here it doesn't matter which undervoltage element is adjusted to a lower threshold.

The output relay of undervoltage element $U1<$ is an idle-current relay, that of the $U2<$ element is a working current relay. The contact positions for the different operating states are shown in fig. 2.5.

If the voltage drops below the set tripping thresholds, the relay trips after elapse of the tripping delay.

4. Operation and settings

All operating elements needed for setting parameters are located on the front plate of the XU1-DC as well as all display elements.

This makes it possible that all adjustments of the relay can be made or changed without disconnecting the unit from the DIN-rail.

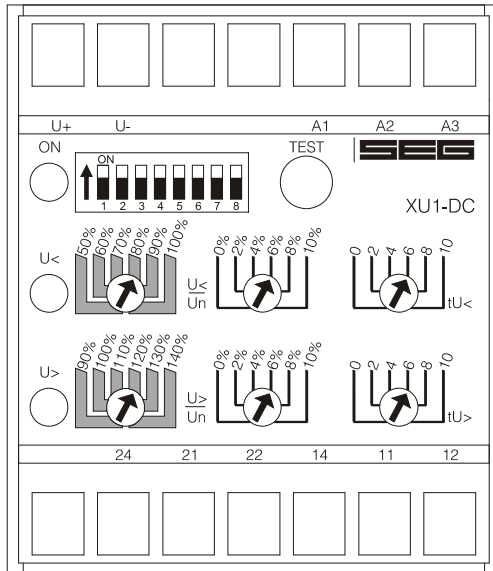

Figure 4.1: Front plate XU1-DC-1 and XU1-DC-2

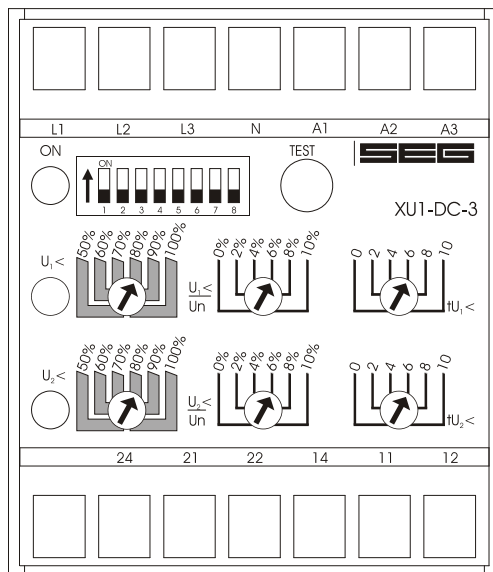

Figure 4.2: Front plate XU1-DC-3

For adjustment of the relay please open the transparent cover as illustrated. Do not use force! The transparent cover has two inserts for labels.

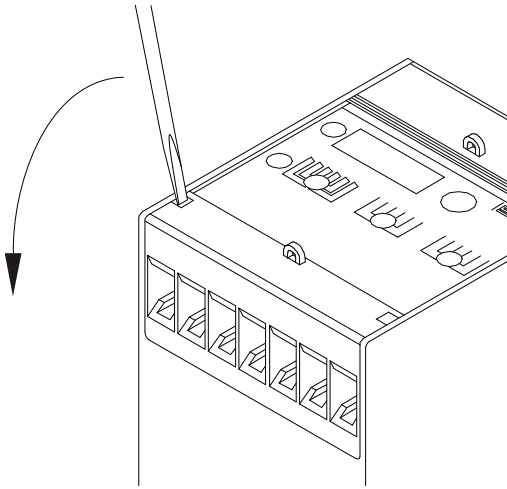

Figure 4.3: How to open the transparent cover

LEDs

LED "ON" is used for the display of readiness for operation (at applied auxiliary voltage U_v). LEDs $U_>$ and $U_<$ ($U_{1<}$ and $U_{2<}$ at XU1-DC-3) indicate pickup (flashing light) or tripping (steady light).

Test push button

This push button is used for test tripping of the unit and when pressed for 5 s a check-up of the hardware takes place. Both output relays are tripped and all tripping LEDs light up.

4.1 Setting of DIP-switches

The DIP-switch block on the front plate of the XU1-DC is used for adjustment of the nominal values and setting of function parameters.

DIP-switch	OFF	ON	Functions
1*	Un = 100 V	Un = 200 V	Setting of rated voltage
2*	Un = 100 V	Un = 400 V	
3*	Un = 100 V	Un = 500 V	
4*	x 1 s	x 10 s	multiplier for tU<
5*	x 1 s	x 10 s	multiplier for tU>
6*	1 %	2 %	Setting of switching hysteresis
7*	1 %	5 %	
8*	1 %	10 %	

Table 4.1: Adjustment possibilities for the XU1-DC-1

* Only one of the DIP-switches 1 -3 or 6 - 8 shall be in „ON“ position at the same time.

DIP-switch	OFF	ON	Functions
1*	Un = 24 V	Un = 48 V	Setting of rated voltage
2*	Un = 24 V	Un = 60 V	
3*			
4*	x 1 s	x 10 s	multiplier for tU<
5*	x 1 s	x 10 s	multiplier for tU>
6*	1 %	2 %	Setting of switching hysteresis
7*	1 %	5 %	
8*	1 %	10 %	

Table 4.2: Adjustment possibilities for the XU1-DC-2

* Only one of the DIP-switches 1 - 2 or 6 - 8 shall be in „ON“ position at the same time.

DIP-switch	OFF	ON	Functions
1*	Un = 24 V	Un = 48 V	Setting of rated voltage
2*	Un = 24 V	Un = 60 V	
3*			
4*	x 0.1 s	x 1 s	multiplier for tU1<
5*	x 0.1 s	x 1 s	multiplier for tU2<
6*	1 %	2 %	Setting of switching hysteresis
7*	1 %	5 %	
8*	1 %	10 %	

Table 4.3: Adjustment possibilities for the XU1-DC-3

* Only one of the DIP-switches 1 - 2 or 6 - 8 shall be in „ON“ position at the same time.

Rated voltage

The required rated voltage at XU1-DC can be set with the aid of DIP-switch 1-2 or 1-3. It has to be ensured that only one of the two or three DIP-switches is switched on. The following DIP-switch configurations for adjustment of the rated voltage are allowed.

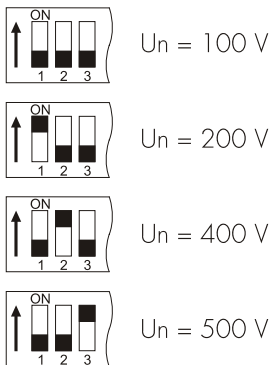

Figure 4.4: Adjustment of rated voltage XU1-DC-1

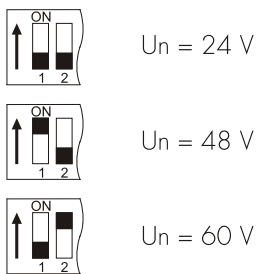

Figure 4.5: Adjustment of rated voltage XU1-DC-2 and XU1-DC-3

Rated voltage chosen too low does not cause destruction of the unit but leads to wrong measuring results which may lead to false tripping.

Switching hysteresis

By using DIP switches 6 - 8 the switching hysteresis of the two trip relays can be adjusted to 1%, 2%, 5% or 10% of the tripping values. As for the rated voltage it has to be ensured that only one of the three DIP switches is switched on at a time.

The following adjustments of the switching hysteresis for $U >$ and $U <$ or $U1 <$ and $U2 <$ are possible:

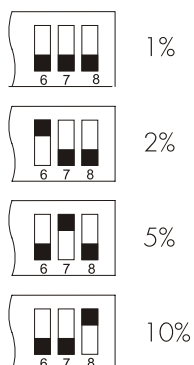

Figure 4.6: Adjustment of the switching hysteresis

4.2 Setting of tripping values

The PROFESSIONAL LINE units have the unique possibility of high accuracy fine adjustments. For this, two potentiometers are used. The coarse setting potentiometer can be set in discrete steps of 10 %. A second fine adjustment potentiometer is then used for continuously variable setting of the final 0 - 10 %. Adding of the two values results in the precise tripping value.

Undervoltage element

By using the potentiometer shown on the following figure, the undervoltage element can be adjusted in the range from 50 % to 110 % U_n .

Example:

The requested tripping value to be set is $U_<$ (or $U_{1<}$ and $U_{2<}$ at XU1-DC-3) of 86 % U_n . To achieve this, the setting value of the potentiometer on the right is simply to be added to the value of the coarse potentiometer. (The arrow of the coarse potentiometer must always be in the middle of the marked bar, otherwise a definite setting value is not possible).

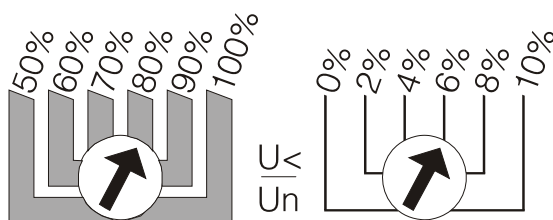

Figure 4.7: Adjustment example

Undervoltage element

The overvoltage trip relay can be adjusted in a range from 90 % to 150 % U_n . Setting procedure the same as for the undervoltage trip relay.

Time delays

The time delays for the undervoltage and overvoltage trip relays can be set in the range from 0 - 100 s or from 0 - 10 s at XU1-DC-3 respectively.

4.3 Communication via serial interface adapter XRS1

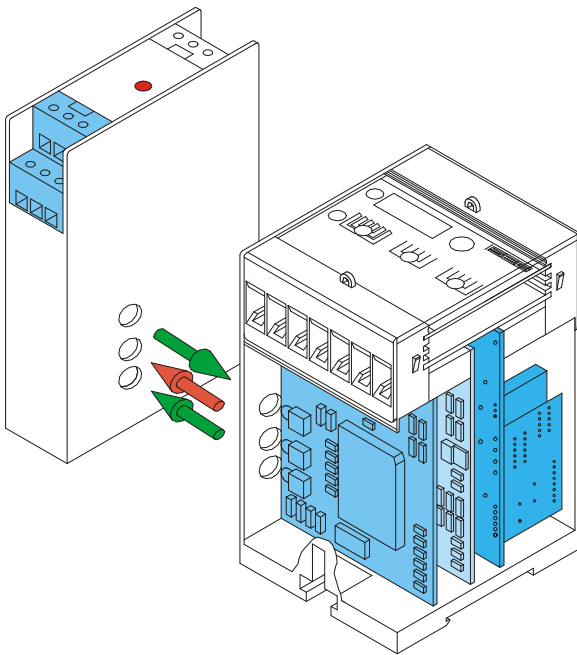

Figure 4.8: Communication principle

For communication of the units with a superior management system the interface adapter XRS1 is available for data transmission including operating software for our relays. This adapter can easily be retrofitted at the side of relay. Screw terminals simplify its installation. Optical transmission of this adapter makes galvanic isolation of the relay possible. Aided by the software, actual measured values can be processed, relay parameters set and protection functions programmed at the output relays. Information about unit XRS1 in detail can be taken from the description of this unit.

5. Relay case and technical data

5.1 Relay case

Unit XU1-DC is designed to be fastened with onto a DIN-rail acc. to DIN EN 50022, same as all units of the PROFESSIONAL LINE.

The front plate of the relay is protected with a sealable transparent cover (IP40).

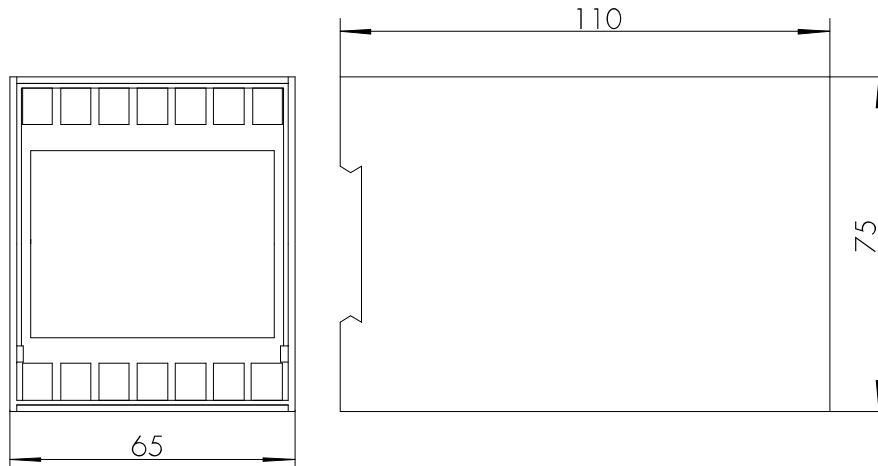

Figure 5.1: Dimensional drawings

Connection terminals

The connection of up to a maximum of $2 \times 2.5 \text{ mm}^2$ cross-section conductors is possible. For this the transparent cover of the unit has to be removed (see chapter 4).

5.2 Technical Data

Measuring input circuits	
Rated voltage U_n :	100, 200, 400, 500 V DC (XU1-DC-1) 24, 48, 60 V DC (XU1-DC-2 and XU1-DC-3)
Power consumption of the voltage circuit:	1 VA
Thermal capacity of the voltage circuit:	DC-1 = 750 V DC continuously DC-2 = 90 V DC continuously DC-3 = 90 V DC continuously
Auxiliary voltage	
Rated auxiliary voltage U_v :	DC-1: 36 - 520 V AC ($f = 35 - 78$ Hz) or 50 - 750 V DC/ 4 W (terminals A1-A3)
Power consumption:	19 - 55 V DC / 3 W (terminals A1(L-) and A2(L+))
DC-2 and DC-3:	11 - 90V DC / 4 W (terminals A1(L-) and A3(L+)) (Initial operating voltage >12.8 V DC, Relay switches off at <9 V)

Common data

Dropout to pickup ratio:	depending on the adjusted hysteresis
Resetting time from pickup:	<50 ms
Returning time from trip:	200 ms
Minimum response time:	50 ms

Output relay

Number of relays:	2
Contacts:	1 changeover contact each for trip relay
Maximum breaking capacity:	ohmic = 1250 VA/AC or 120 W/DC inductive = 500 VA/AC or 75 W/DC
Max. rated voltage:	250 V AC
220 V DC	ohmic load $I_{max.} = 0,2$ A inductive load $I_{max.} = 0,1$ A at $L/R \leq 50$ ms
24 V DC	inductive load $I_{max.} = 5$ A
Minimum load:	1 W / 1 VA at $U_{min} \geq 10$ V
Max. rated current:	5 A
Making current (16 ms):	20 A
Contact life span:	10^5 operations at max. breaking capacity

System data

Design standards:	VDE 0435 T303; IEC 0801 part 1-4, VDE 0160; IEC 255-4; BS 142; VDE 0871
-------------------	--

Climatic stress:

Temperature range at storage and operation:	-25°C to +70°C
---	----------------

Climatic resistance class F acc. to DIN 40040 and DIN IEC 68, T.2-3:	more than 56 days at 40 °C and 95 % relative humidity
--	---

High voltage test acc. to VDE 0435, part 303	
Voltage test:	2.5 kV (eff.), 50 Hz - 1 min
Surge voltage test:	5 kV, 1.25/50 μ s, 0.5 J
High frequency test:	2.5 kV/1MHz

Electrostatic discharge (ESD) acc. to IEC 0801 part 2:	8 kV
Radiated electro-magnetic field test acc. to IEC 0801 part 3:	10 V/m
Electrical fast transient. (burst) acc. to IEC 0801 part 4:	4 kV / 2.5 kHz, 15 ms
Radio interference suppression test acc. to DIN 57871 and VDE 0871:	limit value class A
Repeat accuracy:	1 %
Basic time delay accuracy:	0.5 % or ± 25 ms

Accuracy of the specific

rated values:	0.75 %
Temperature effects:	0.02 % per K

Mechanical test

Shock:	class 1 acc. to DIN IEC 255-21-2
Vibration:	class 1 acc. to DIN IEC 255-21-1

Degree of protection

Front panel:	IP40 when the front cover is closed
Weight:	approx. 0.5 kg
Mounting position:	any
Relay case material:	self-extinguishing
GL-Approval:	94657-94HH

Parameter	Setting range	Graduation
U<	50 - 110 % Un	continuously variable
U>	90 - 150 % Un	continuously variable
tU</tU>	0 - 100 s	continuously variable
Hysteresis for U> and U<	1, 2, 5, 10 %	

Table 5.1: Setting ranges and graduation of XU1-DC-1 and XU1-DC-2

Parameter	Setting range	Graduation
U1<	50 - 110 % Un	continuously variable
U2<	50 - 110 % Un	continuously variable
tU1</tU2<	0 - 10 s	continuously variable
Hysteresis for U1< and U2<	1, 2, 5, 10 %	

Table 5.2: Setting ranges and graduation of XU1-DC-3

6. Order form

DC voltage relay	<i>XU1DC</i>	
Rated voltage 100 - 500 V/DC		1
24 - 60 V/DC		2
with two under-voltage elements 24 - 60 V/DC		3

Technical data subject to change without notice!

Setting-list XU1-DC

Project: _____ SEG job.-no.: _____

Function group: = _____ Location: + Relay code: - _____

Relay functions: _____ Date: _____

Setting of parameters at XU1-DC-1 and XU1-DC-2

Function		Unit	Default settings	Actual settings
U<	Undervoltage tripping	% Un	50	
U>	Overvoltage tripping	% Un	90	
tU<	Time delay for U<	s	0	
tU>	Time delay for U>	s	0	

DIP switch settings at XU1-DC-1 and XU1-DC-2

DIP-switch	Function	Default settings	Actual settings
1*	Setting of rated voltage XU1-DC1	Un = 100 V (24 V)	
2*	(In brackets XU1-DC2)	Un = 100 V (24 V)	
3*	Setting of rated voltage XU1-DC1	Un = 100 V	
4	Multiplier for tU<	x 1 s	
5	Multiplier for tU>	x 1 s	
6*	Setting of switching hysteresis	1 %	
7*	Setting of switching hysteresis	1 %	
8*	Setting of switching hysteresis	1 %	

*Only one of the DIP-switches 1 - 3 or 6 - 8 shall be in „ON“-position at the same time.

Setting of parameters at XU1-DC-3

Function		Unit	Default settings	Actual settings
U1<	Undervoltage tripping	% Un	50	
U2<	Undervoltage tripping	% Un	50	
tU1<	Time delay for U1<	s	0	
tU2<	Time delay for U2<	s	0	

DIP switch settings at XU1-DC-3

DIP-switch	Function	Default settings	Actual settings
1*	Setting of rated voltage	Un = 24 V	
2*	Setting of rated voltage	Un = 24 V	
3*			
4	Multiplier for tU1<	x 1 s	
5	Multiplier for tU2<	x 1 s	
6*	Setting of switching hysteresis	1 %	
7*	Setting of switching hysteresis	1 %	
8*	Setting of switching hysteresis	1 %	

*Only one of the DIP-switches 1 - 3 or 6 - 8 shall be in „ON“-position at the same time.



AvK Generátory s.r.o.
ul. 4. května 175
755 01 Vsetín (Czech Republic)

Tel.: +420 571 413 322
<http://www.woodward-seg.cz>
info@woodward-seg.cz